

Data Sheet

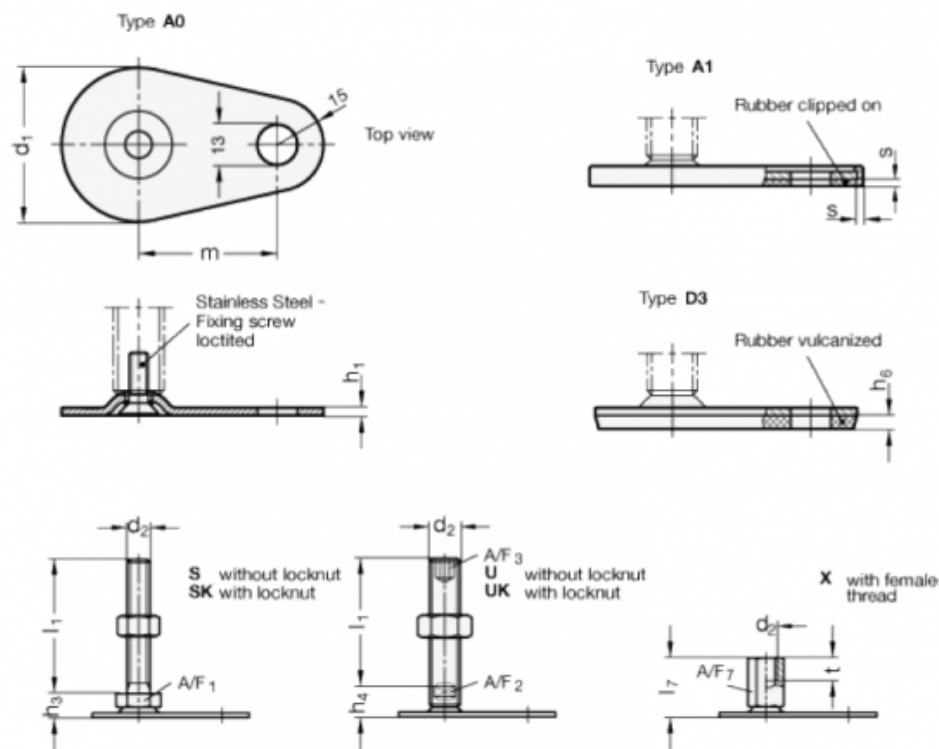

Article number: 204250M1050D3SK
 Description: E+G levelling foot
 GN 42-50-M10-50-D3-SK
 Note: SK With nut, External hexagon at the bottom

Measures



A/F1 = 17
 d1 = 50
 d2 = M10
 h1 = 2.5
 h3 = 11
 h6 = 4
 l1 = 50
 m = 45

s =